

Masonite Beams Installation Guide for Floor System Construction



Safety Bracing Details

UNBRACED JOISTS ARE UNSTABLE!

- Do not walk on or apply any materials to the joist area until the floor system is properly braced.
- The bracing should be removed in sequence as the decking is installed.
- The following represents a generic method of bracing a floor. Each system will be slightly different and the installer must ensure that all sections of the floor are accounted for.

REFER TO TECHNICAL BULLETIN FOR DETAILS OF LOADING OUT DURING CONSTRUCTION

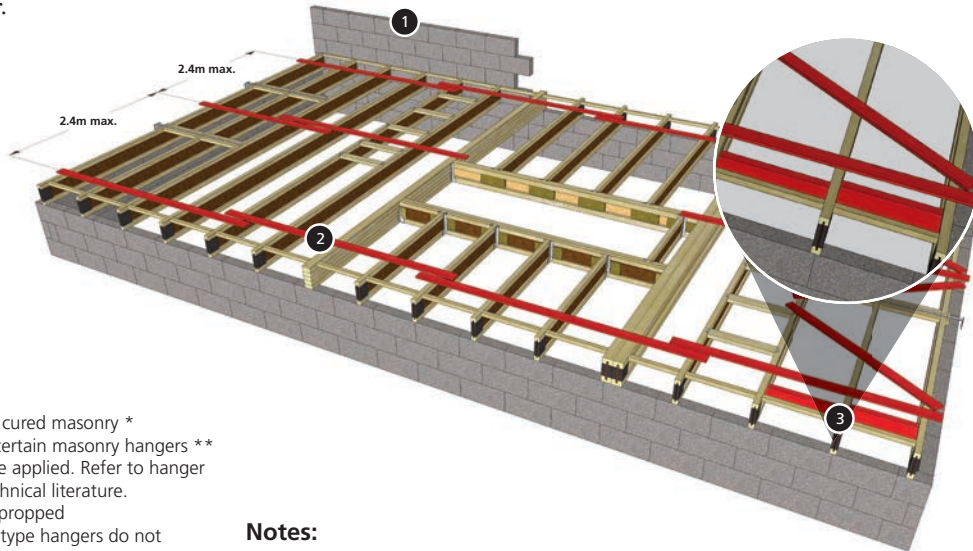

- 1 Minimum 675mm cured masonry * is required above certain masonry hangers ** before load may be applied. Refer to hanger manufacturer's technical literature.
* or joists may be propped
** safety restraint type hangers do not
- 2 22 x 97mm softwood bracing members nailed with 2no. 3.35 x 65mm nails at each joist.
- 3 38 x 125mm timber stability blocks to be fixed between at least 3 joists, covering at least 1.2m in length. Nail with at least 2no. 3.35 x 65mm nails each end.

Notes:

- Full depth I-joist blocking panels may be used instead of solid timber stability blocks.
- All blocks to be cut accurately and squarely to maintain spacing of joists.
- Additional blocks and bracings are required for any areas of joists running in opposite directions and for cantilevered joists (unless permanent closure piece is installed at this stage). Install further sets of blocks and diagonals at a maximum of 12m centres in long runs of joists.

MULTIPLE PLY GLULAM MEMBERS - FIXING DETAILS

Allowable uniform load applied to multiple glulam beam kN/m

FIXINGS	SPACING	NO. OF ROWS	PLY THICKNESS							
			2 PLY MEMBERS			3 PLY MEMBERS			4 PLY MEMBERS	
			38 + 38 kN/m	45 + 45 kN/m	90 + 90 kN/m	All 38mm kN/m	All 45mm kN/m	All 90mm kN/m	All 38mm kN/m	All 45mm kN/m
3.1mmØ x 90mm long nails (75mm nails for 38mm plies)	300mm	2	5.81	5.95	–	4.36	4.46	–	–	–
		3	8.72	8.92	–	6.54	6.69	–	–	–
	600mm	2	2.91	2.97	–	2.18	2.23	–	–	–
		3	4.36	4.46	–	3.27	3.35	–	–	–
3.75mmØ x 90mm long nails (75mm nails for 38mm plies)	300mm	2	6.88	8.00	–	5.16	6.00	–	–	–
		3	10.32	12.00	–	7.74	9.00	–	–	–
	600mm	2	3.44	4.00	–	2.58	3.00	–	–	–
		3	5.16	6.00	–	3.87	4.50	–	–	–
4.0mmØ x 90mm long nails (75mm nails for 38mm plies)	300mm	2	8.00	8.68	–	5.30	6.51	–	–	–
		3	12.00	13.02	–	7.95	9.77	–	–	–
	600mm	2	4.00	4.34	–	2.65	3.26	–	–	–
		3	6.00	6.51	–	3.98	4.88	–	–	–
M12 - 4.6 bolts	300mm	2	15.99	18.93	32.51	30.88	36.57	65.53	20.59	24.38
		3	23.98	28.40	48.77	46.32	54.85	97.55	30.88	36.57
	600mm	2	7.99	9.47	16.26	15.44	18.28	32.52	10.29	12.19
		3	11.99	14.20	24.39	23.16	27.43	48.78	15.44	18.28

Notes:

All design capacities are for medium term term loading in service class 1 & can be used for glulam & LVL members
 Table shows the maximum design load which can be applied on one face of the multiple member, applied perpendicular to the grain.
 For 2 ply members, nails are driven from one face, for 3 ply members the nails are driven through each of the outer timbers into the centre ply using the same pattern from each face but staggered.
 M12 bolts are 4.6 grade, fitted with 36mm diameter washers, 3.6mm thick

A1 MASONRY WALL RESTRAINT – PERPENDICULAR TO JOIST

- 1 Thin metal restraint strap installed in accordance with the manufacturer's instructions
- 2 Min. 38 x 97/122/147mm nogging fixed to joists by skew nails or using z clips

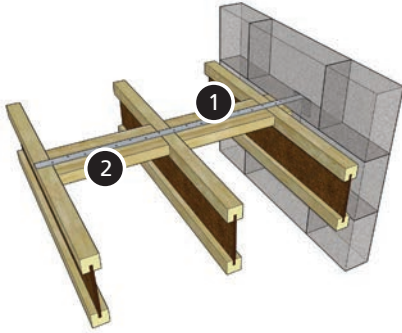

A2 MASONRY WALL RESTRAINT – PARALLEL TO JOIST

- 1 Restraint strap fitted to joist on non-restraint type masonry hanger
- 2 Parallel restraint straps may only be omitted if the joist has at least 90mm of direct bearing on the wall, provided that the height of the wall does not exceed 2 storeys
- 3 Restraint strap on built-in joist

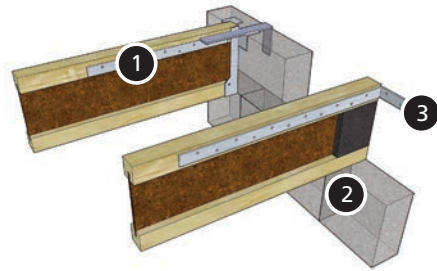

A3 PARALLEL PARTITION NOGGINGS

- 1 Non-load bearing stud partition fixed to noggings
- 2 38 x 75mm partition noggings supported by metal z-clips, nailed in accordance with the manufacturer's instructions
- i Noggings may also be attached with 2no. 3.35 x 65mm nails skew nailed at each end

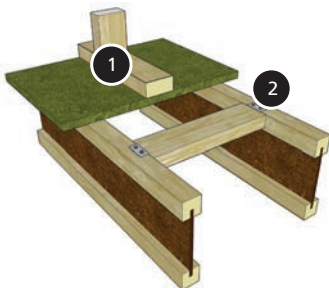

A4 PERIMETER NOGGINGS

- 1 Noggings may be skew nailed to joists or supported on z-clips
- 2 Timber noggings fitted between joists to support free edges of decking at external or internal walls. Also applicable to masonry walls

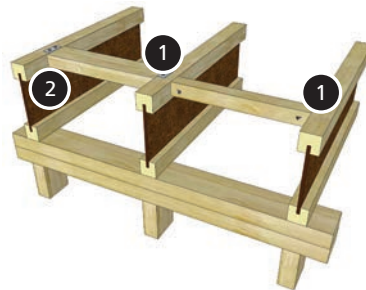

B1 I-JOIST BLOCKING PANEL

- 1 Masonite I-Joist blocking panel
- 2 Joist has full bearing on timber plate

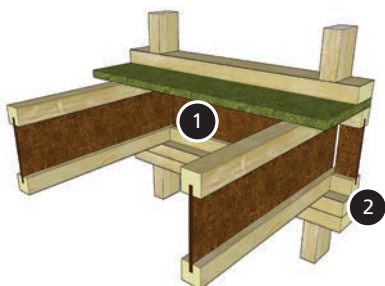

B2 RIM I-JOIST

- 1 Masonite I-Joist rim board
- 2 Joist requires 45mm minimum bearing

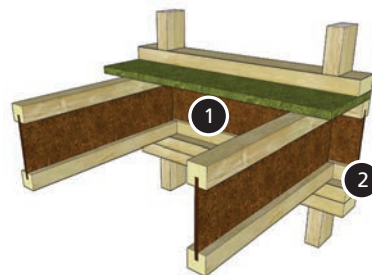

B3 RIM BOARD

- 1 38mm Glulam or 30mm LVL, or to suit wall load
- 2 Joist requires 45mm minimum bearing

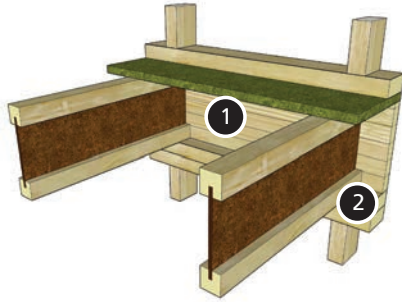

B4 MASONRY HANGER

- 1 Perimeter nogging for decking support where required
- 2 Proprietary approved masonry joist hangers - web stiffeners may be required, see notes on page 16
- i Parallel restraint straps will be required with non-restraining hangers — see A2

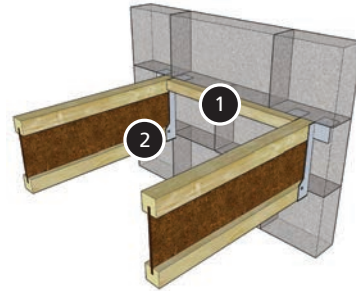

B5 MASONRY WALL BEARING

- 1 Joist end built into wall. Note some capping devices may require less than a full bearing to prevent fouling the cavity
- 2 Perimeter nogging
- i The joist bearing must be sealed to prevent air leakage. This may be achieved by the use of proprietary capping devices or end blocks fitted to the joist webs with sealant around the joist ends.

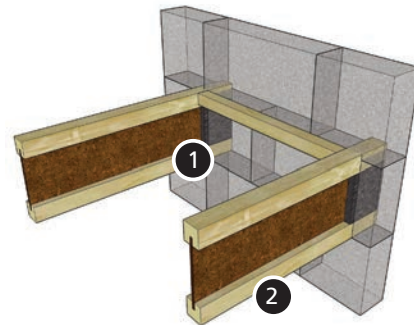

B6 PARALLEL TIMBER FRAME WALL

- 1 Masonite I-Joist with half bearing into wall
- 2 38mm Glulam or 30mm LVL, or to suit wall load

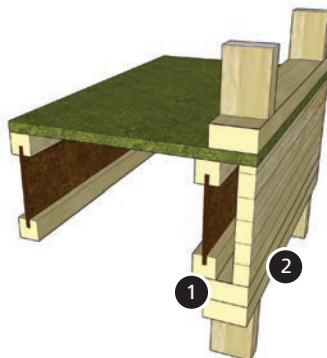

B7 INTERMEDIATE BEARING — LOAD BEARING WALL ABOVE

- 1 Load bearing wall directly above wall below
- 2 Masonite I-Joist blocking panels between joists

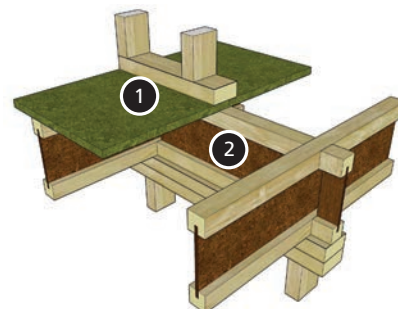

B8 INTERMEDIATE BEARING COMPRESSION BLOCKS

- 1 Load bearing wall directly above wall below
- 2 Height of compression blocks = joist depth + 2m
- 3 38 x 89mm minimum softwood compression blocks

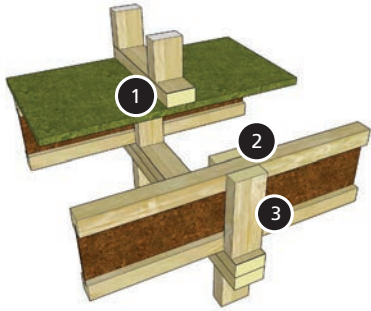

B9 INTERMEDIATE BEARING NO LOAD BEARING WALL ABOVE

- 1 Web stiffeners where required

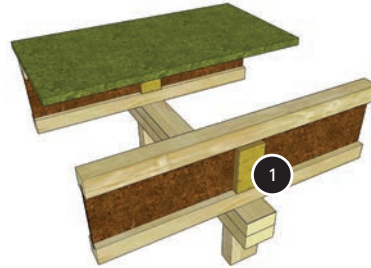

B10 INTERMEDIATE BEARING MASONRY WALL

- 1 Perimeter nogging
- 2 Minimum 89mm bearing

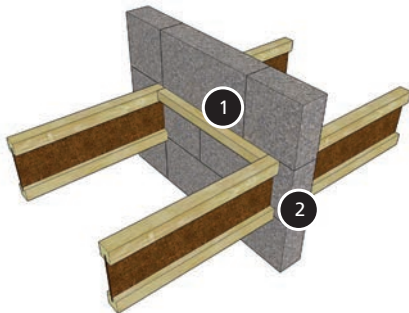

B11 INTERMEDIATE BEARING DOUBLE BLOCKING

- 1 Load bearing wall directly above wall below
- 2 Webs of blocking in line with edge of stud wall above and below

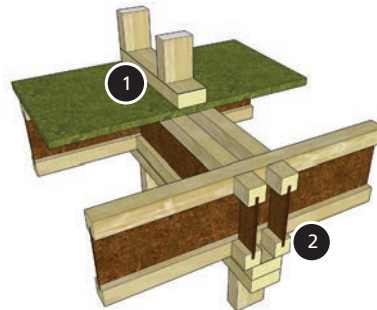

B12 COLUMN WITH COMPRESSION BLOCKS

- 1 Softwood compression blocks, min. 38 x 89mm, height = joist depth + 2mm
- 2 I-Joist blocking panels
- i Number of blocks to suit width of column above

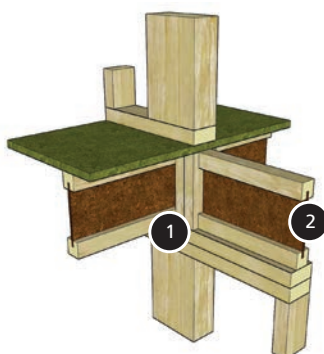

B13 CANTILEVER SUPPORTING WALL

- 1 I-Joist Blocking
- 2 38mm Glulam or 30mm LVL
- i Structural cantilever must not exceed 600mm

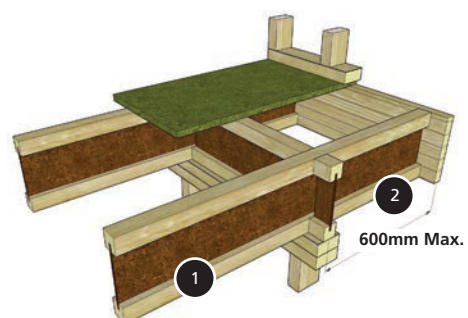

B14 REINFORCED CANTILEVER SUPPORTING WALL

- 1 19mm ply reinforcement one or both sides of cantilevered joists, (determined by loading) nailed at 150mm centres with 3.35mm dia. nails, 65mm long. Stagger nails when fixing ply both sides
- 2 I-Joist Blocking
- i Structural cantilever must not exceed 600mm

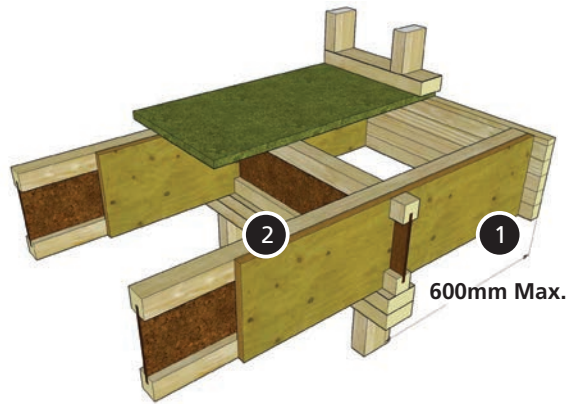

B15 NON LOAD BEARING CANTILEVER

- 1 I-Joist Blocking
- 2 38mm Glulam or 30mm LVL
- i Max. cantilever length is 1200mm. No load applied on cantilever

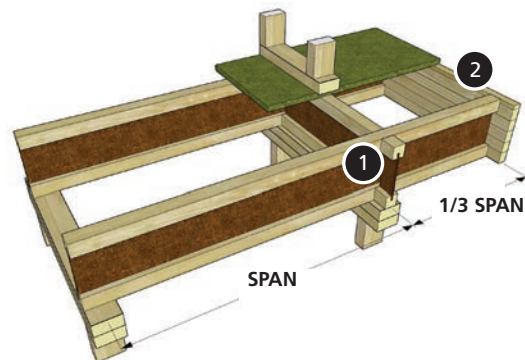

B16 WALLPLATE CONNECTION

- 1 Top mount hangers
- 2 Timber bearing plate securely fixed to flange of steel beam/masonry wall (design of fixings by Building Designer)

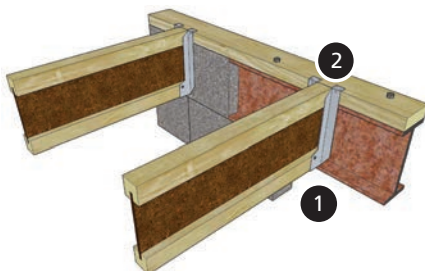

C1 I-JOIST TO SOLID BEAM CONNECTION

- 1 Top mount hanger
- 2 Face mount hanger
- 3 Glulam beam or similar approved
- 4 Face mount hangers which do not laterally support the joist top flange require webstiffeners

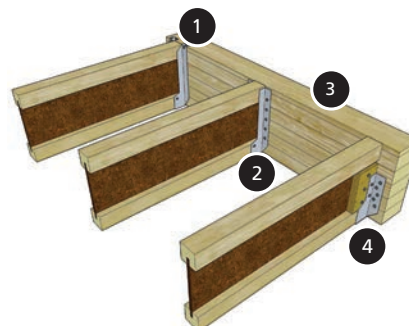

C2 I-JOIST TO I-JOIST CONNECTION

- 1 Top mount hanger
- 2 Filler block or proprietary metal clips must be installed with multiple joists
- 3 Backer block on hanger face only for double joist
- 4 Backer block both sides of single joist
- 5 Face mount hanger
- 6 Double I-Joist

i Backer blocks nailed with 10no. 3.75mm diameter nails x 75mm long, with ends clinched if possible.

Use 10no. 4.00mm nails x 90mm long, for HB joists.

For top mount hangers, backer block tight to top flange of joist.

For face mount hangers, backer block tight to bottom flange.

Filler blocks fitted tight to top flange.

Note that approved hangers which eliminate the need for backer blocks are available. See detail C3.

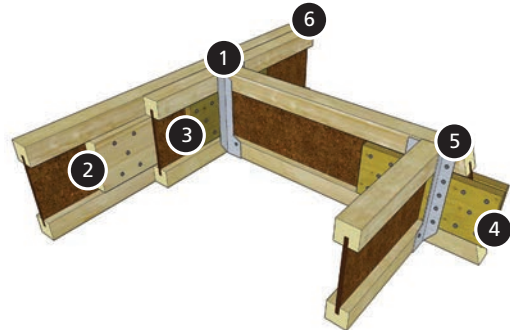

C3 I-JOIST TO I-JOIST CONNECTION – BACKERLESS

- 1 Filler block or proprietary metal clips must still be installed with multiple joists
- 2 Approved hanger designed for use without backer blocks

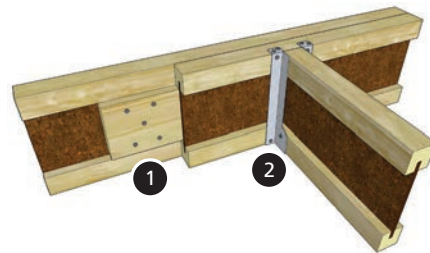

Allowable Holes

THE FOLLOWING TABLES MAY BE USED TO DETERMINE THE DISTANCE FROM BEARINGS OR POINT LOADS FOR JOIST/SPAN/HOLE COMBINATIONS:

		Circular Holes – distance in m from bearing/point load to nearest hole edge							
JOIST DEPTH	JOIST CLEAR SPAN	75	100	125	150	175	200	250	MAX HOLE
220mm Max. 126mm hole	3.0	0.22	0.22	0.55					0.58
	3.5	0.22	0.22	0.71					0.75
	4.0	0.22	0.22	0.89					0.92
	4.675	0.22	0.27	1.14					1.17
240mm Max. 146mm hole	3.5	0.24	0.24	0.24					0.72
	4.0	0.24	0.24	0.25					0.9
	4.5	0.24	0.24	0.37					1.08
	4.933	0.24	0.24	0.51					1.24
300mm Max. 206mm hole	4.0	0.30	0.30	0.30	0.30	0.30	0.60		0.79
	4.5	0.30	0.30	0.30	0.30	0.30	0.77		0.97
	5.0	0.30	0.30	0.30	0.30	0.30	0.95		1.15
	5.634	0.30	0.30	0.30	0.30	0.60	1.18		1.39
350mm Max. 256mm hole	4.5	0.35	0.35	0.35	0.35	0.35	0.35	0.66	0.84
	5.0	0.35	0.35	0.35	0.35	0.35	0.35	0.83	1.02
	5.5	0.35	0.35	0.35	0.35	0.35	0.35	1.01	1.21
	6.160	0.35	0.35	0.35	0.35	0.35	0.35	1.33	1.46
400mm Max. 306mm hole	5.0	0.40	0.40	0.40	0.40	0.40	0.40	0.40	0.89
	5.5	0.40	0.40	0.40	0.40	0.40	0.40	0.40	1.07
	6.0	0.40	0.40	0.40	0.40	0.40	0.40	0.40	1.29
	6.645	0.40	0.40	0.40	0.40	0.40	0.40	0.50	1.62

		Rectangular Holes – distance in m from bearing/point load to nearest hole edge			
JOIST DEPTH	JOIST CLEAR SPAN	100h x 100w	100h x 200w	200h x 200w	200h x 300w
220mm Max. 126h x 252w	3.0	0.22	0.64		
	3.5	0.22	0.83		
	4.0	0.35	0.99		
	4.675	0.55	1.25		
240mm Max. 146h x 292w	3.5	0.24	0.79		
	4.0	0.31	0.96		
	4.5	0.45	1.15		
	4.933	0.59	1.31		
300mm Max. 200h x 300w	4.0	0.30	0.88	0.72	1.06
	4.5	0.34	1.06	0.89	1.25
	5.0	0.50	1.25	1.07	1.45
	5.634	0.82	1.50	1.30	1.71
350mm Max. 200h x 300w	4.5	0.35	1.00	0.82	1.20
	5.0	0.45	1.18	1.00	1.39
	5.5	0.70	1.37	1.18	1.59
	6.160	1.03	1.63	1.42	1.86
400mm Max. 200h x 300w	5.0	0.40	1.12	0.93	1.34
	5.5	0.65	1.31	1.11	1.53
	6.0	0.90	1.50	1.29	1.73
	6.645	0.1.23	1.75	1.60	2.00

Notes:

All values above are valid for uniformly distributed loads of normal residential magnitude; 1.5kN/m2 Imposed Load, 0.5kN/m2 Dead Load and 0.25kN/m2 Partition Load.

The maximum hole size allowed within each joist depth is shown in column one

The distance from a bearing required when applying the maximum diameter circular hole is the column on the right

The joist clear spans are indicative examples except for the last span which is the maximum achievable with the joist depth at 600mm centres

The remaining columns show the distance from a bearing or point load required for each hole diameter

MASONITE BEAMS

The following categories describe the opportunities to place holes within the web of the joists

SMALL DIAMETER HOLES – UP TO AND INCLUDING 20mm

Holes up to and including 20mm diameter can be placed anywhere in the green zone below. The distance between holes must be twice the diameter of the larger hole

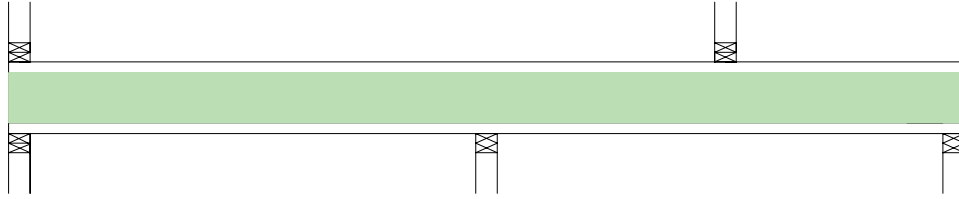

MEDIUM DIAMETER HOLES – FROM 21mm TO 40mm

Individual holes larger than 20mm and up to 40mm can be placed anywhere in the green zone below but must be outside the red hatched safety zones indicated below. These zones extend 150mm from all bearings and point loads.

The distance between holes must be twice the diameter of the larger hole

A maximum of two consecutive holes are allowed if the minimum distance apart is used, and must be placed in the same horizontal plane but don't need to be on the centreline of the web. More than two holes in the same joist reduces shear capacity by 20%

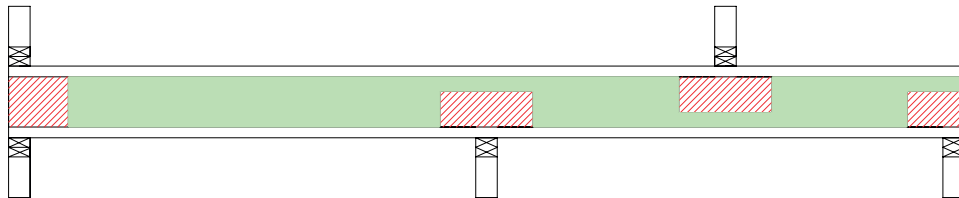

LARGE DIAMETER AND RECTANGULAR HOLES – ABOVE 40mm

Holes over 40mm diameter can be placed anywhere in the green zone below but at least 'H' away from all bearings or point loads. Holes must be placed on the centreline of the web and must not damage the joist flanges

The distance between circular holes must be 'H' or more, the distance between rectangular and other holes must be the larger of 'H' or 2x'A'

Multiple holes may be grouped together and considered to act as a single hole in accordance with the above

Maximum dimensions for rectangular holes are A=300mm and B=200mm, subject to joist depth

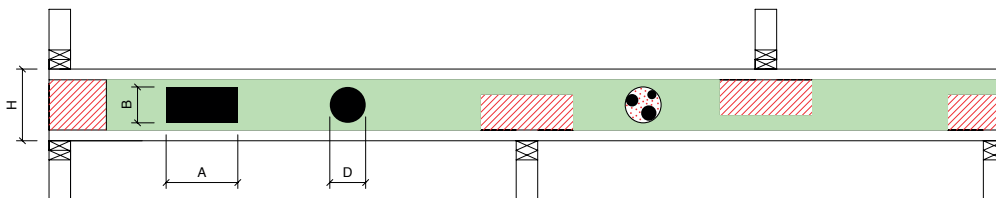

General Notes:

- When holes of differing categories are being cut, the rules relating to the largest hole apply
- Any holes or load conditions falling outside these rules must be checked by our engineering support service.
- Information regarding the calculation of the reduction of shear capacity caused by a hole can be found in Masonite Beams European Technical Approval; ETA 12/0018.
- I-Joist flanges may not be damaged under any circumstances.

SOLID BEAMS

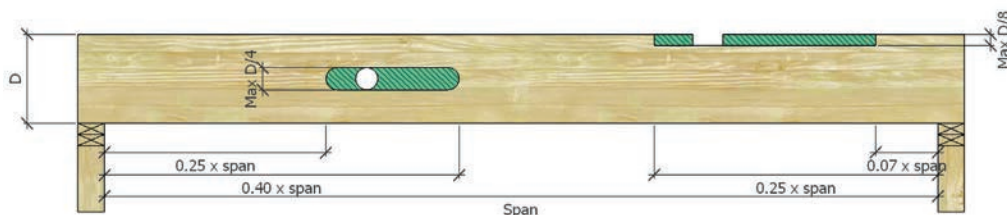

Notes:

Holes must be placed along the neutral axis and spaced apart at least 3 x largest diameter hole. For holes outside these rules please contact engineering support

Product Profiles

Masonite Product Profiles

Notes:

The HL-C24 Joist is identified by a RED + along the side of the flange.

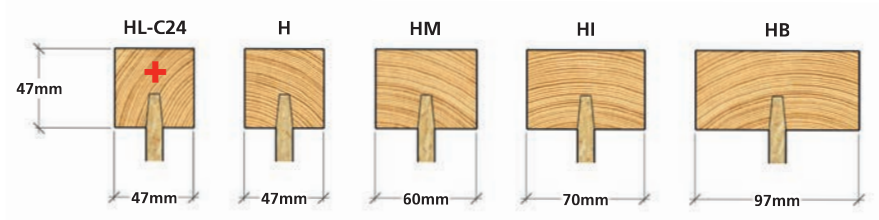

STANDARD DEPTHS mm	HL-C24	H	HM	HI	HB
220	✓	✓	✓	✓	✓
240	✓	✓	✓	✓	✓
300	✓	✓	✓	✓	✓
350			✓		✓
400			✓		✓

THESE CONDITIONS ARE NOT PERMITTED UNDER ANY CIRCUMSTANCES

If in doubt, please ask for advice before you cut.

NO holes close to joist ends

Use hole chart for max. size & min. distance to wall.



NO notches in flanges of Masonite joists

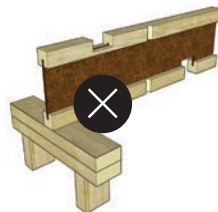

NO bevel cuts beyond the inside face of wall

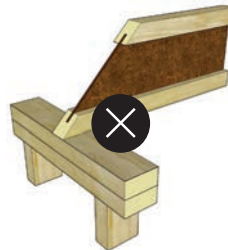

NO notches or holes in Glulam

Except as advised in hole chart for the product.



Storage

Always store joist packs flat, properly covered and above the ground.

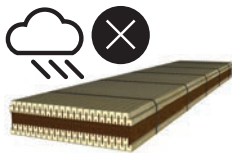

Never store joist packs vertically.

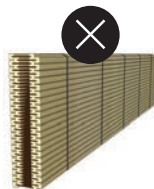

Handling

Never lift or move the joist packs by the flanges.

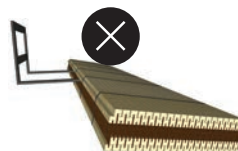

Always follow the HSE guidance on manual handling.



BS EN1995-1-1 Version

Contractors should be aware of their health and safety responsibilities under the Construction (Design and Management) Regulations 2015.

Cirencester Office Park, Unit 18/19,
Tetbury Road, Cirencester, GL7 6JJ, UK
Tel: +44 (0)1285 646000 Fax: +44 (0)1285 646020

www.sodra.com/en-gb/gb

